

ELLA 42" COFFEE TABLE
Assembly Instructions

THIS ASSEMBLY REQUIRES TWO PEOPLE

ITEMS INCLUDED IN THE HARDWARE KIT:

- 1) FOUR (4) STAINLESS STEEL ALLEN BOLTS.
- 2) FOUR (4) STAINLESS STEEL FLAT WASHERS.
- 3) ONE (1) ALLEN WRENCH.

PARTS INCLUDED:

- 1) ONE (1) STONE TOP.



STEP 1:

With another person, place the top on a padded non-abrasive surface with bottom facing upward. Align the holes of the table base with the holes on the table top.

STEP 2:

Insert one allen bolt with flat washer into each threaded holes on the table top. **Hand tight only. Do not continue until all bolts are properly aligned with each holes.**

STEP 3:

Tighten all bolts using the included allen wrench. **Do not over tighten. Do not use electric drill.**

STEP 4:

Once assembled, flip the table and base so that it stands on the table base.

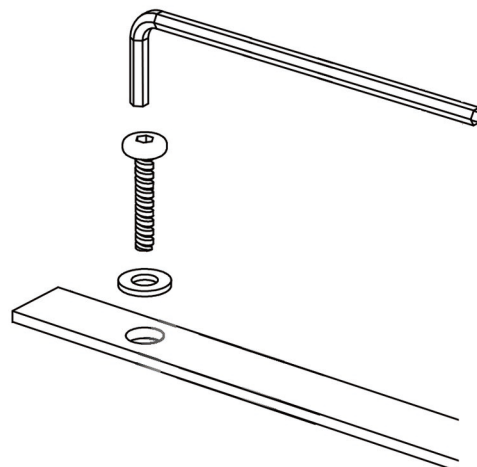
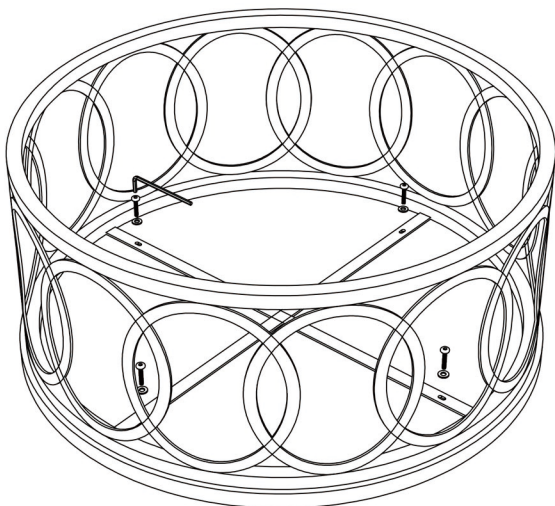

ALLEN WRENCH

ALLEN BOLT

FLAT WASHER