







SCH-168234 VAUGHN BOOKCASE ASSEMBLY INSTRUCTION

Hardware Include :

No	Part	Description	Qty
A		Screw Ø8 x 2"	1 pcs
B		Screw Ø8 x 3/4"	1 pcs
C		Bracket	2 pcs
D		Retention Belt	1 pc
E		Fisher S8	1 pc

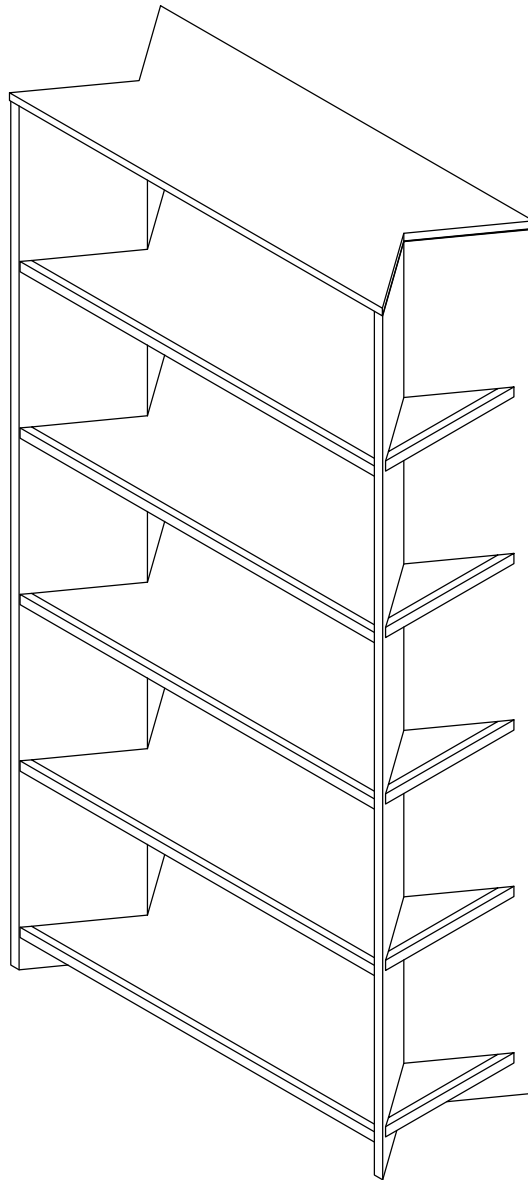



SCH-168234 VAUGHN BOOKCASE ASSEMBLY INSTRUCTION

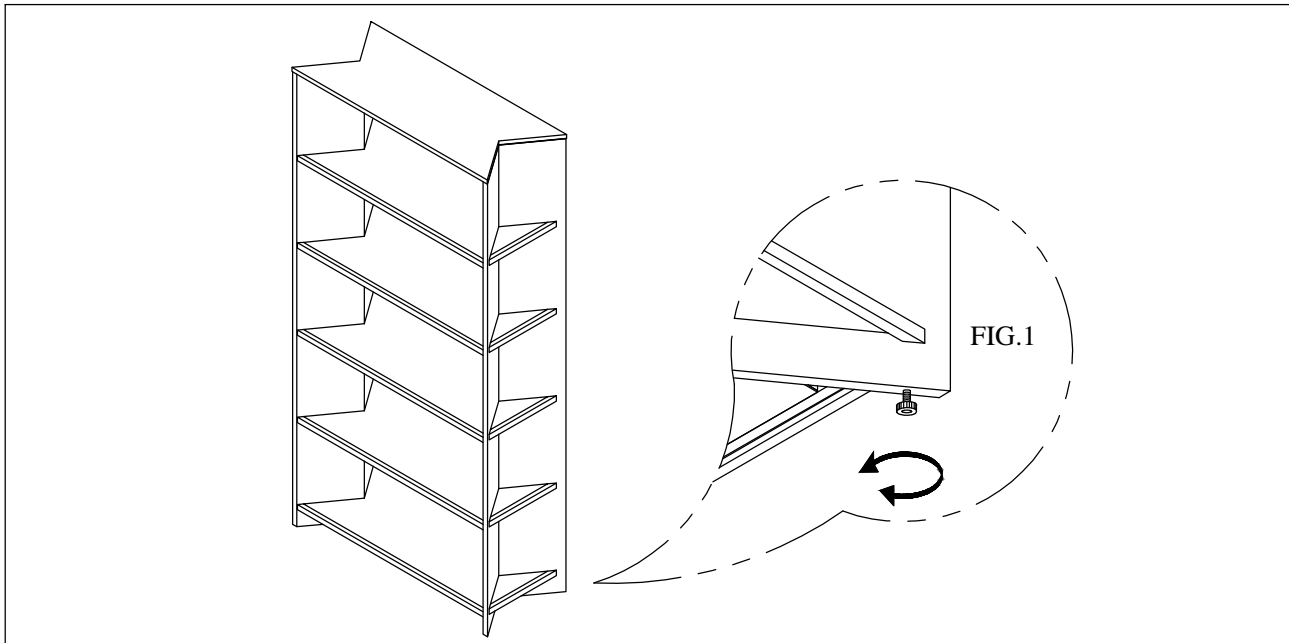

• **STEP 1 :**

If the floor uneven the levelers located at the underside of the Leg, to do this lift Up the side that need to be elevated to provide access to the levelers, turn the leveler until adequate contact with the floor as shown FIG.1

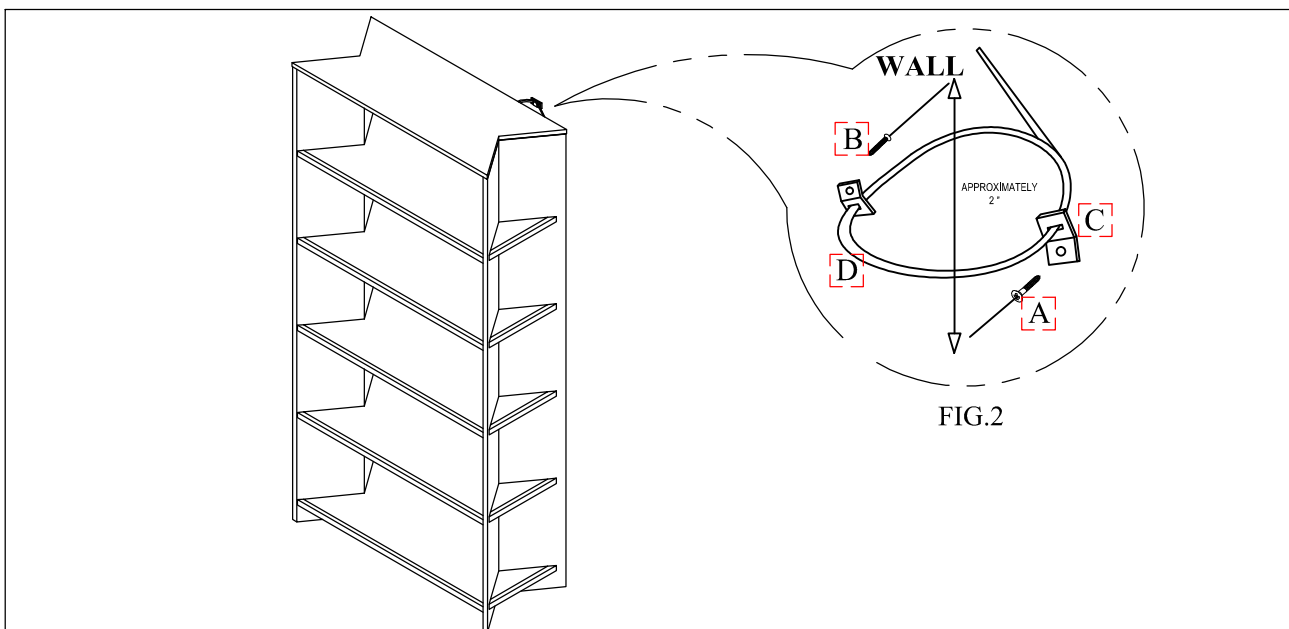

• **STEP 2 :**

The Fisher (E) (wall insert) should be used in conjunction with using a wall stud as anchor. The combination will make the unit very stable. Attach one of the Brackets (C) horizontally to the top of the back of the Desk using the Small Screws (A).Screw the remaining Bracket (C) vertically 1 inch below the brackets attached to the Desk using the large screws (B). The Large Screws (B) should be screwed into a stud in the wall. Align the Brackets vertically and string in the Retention Belt (D). Confirm Strap is securely laced and locked as shown FIG.2.