

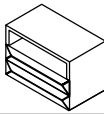



GABBY®



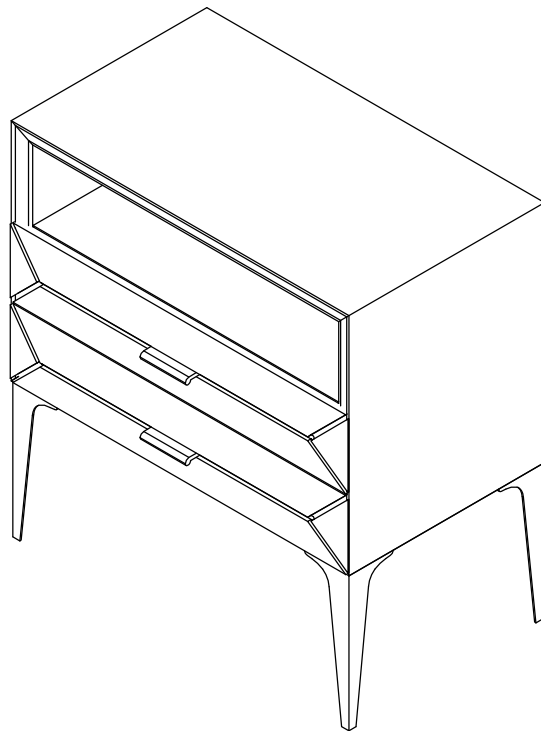

SCH-166310 WHITLEY NIGHTSTAND ASSEMBLY INSTRUCTION

Parts Include :

No	Description		Qty
A	Body		1 pc
B	Legs		4 pcs



Hardware Include :

No	Part	Description	Qty
1		JCBC Bolts M6 X 30 mm	12 pcs
2		Flat Washer	12 pcs
3		Spring Washer	12 pcs
4		Allen Key 4	1 pc

HOW TO ASSEMBLY:

STEP 1:

- Assemble the Body (A) Legs (B) using the JCBC Bolt M6 x 30 mm (1) with Flat Washer (2) and Spring Washer (3) Securely tighten with Allen Key 4 (4) as provided shown *detail 1*;

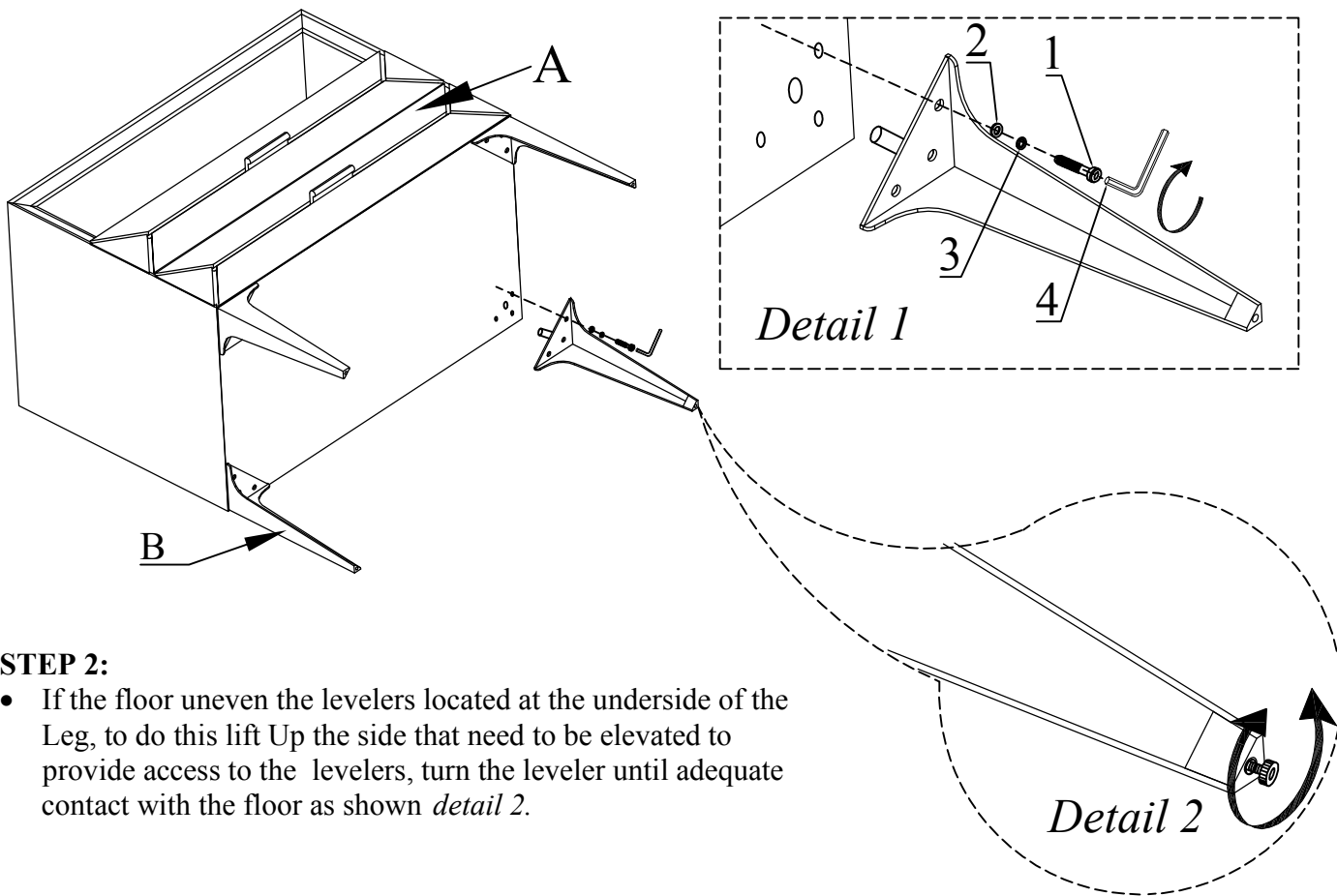

STEP 2:





- If the floor uneven the levelers located at the underside of the Leg, to do this lift Up the side that need to be elevated to provide access to the levelers, turn the leveler until adequate contact with the floor as shown *detail 2*.



GABBY®

SCH-166310 WHITLEY NIGHTSTAND ASSEMBLY INSTRUCTION

Hardware Include :

No	Part	Description	Qty
A		Screw Ø8 x 2"	1 pcs
B		Screw Ø8 x 3/4"	1 pcs
C		Bracket	2 pcs
D		Retention Belt	1 pc
E		Fisher S8	1 pc

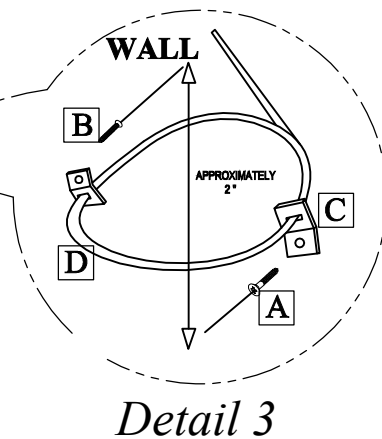
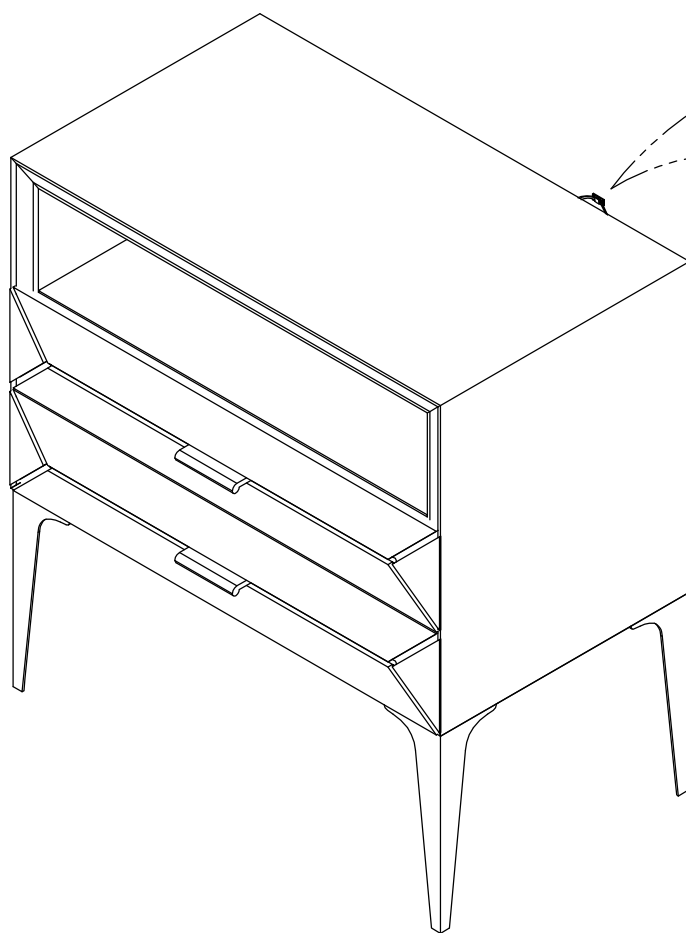

STEP 3 :

- The Fisher (E) (wall insert) should be used in conjunction with using a wall stud as anchor. The combination will make the unit very stable. Attach one of the Brackets (C) horizontally to the top of the back of the Desk using the Small Screws (A). Screw the remaining Bracket (C) vertically 1 inch below the brackets attached to the Desk using the large screws (B). The Large Screws (B) should be screwed into a stud in the wall. Align the Brackets vertically and string in the Retention Belt (D). Confirm Strap is securely laced and locked as shown Detail 3.