







GABBY

SAFFRON / STRELLA  
ASSEMBLY INSTRUCTION

HARDWARE LIST				
NO	DESCRIPTION	DRAWING	Stocksize	QTY
A	Small Screw		3.5 x 15	04
B	Large Screw		3.5 x 30	04
C	Bracket			04
D	Retention Belt			02

NOT PROVIDED :

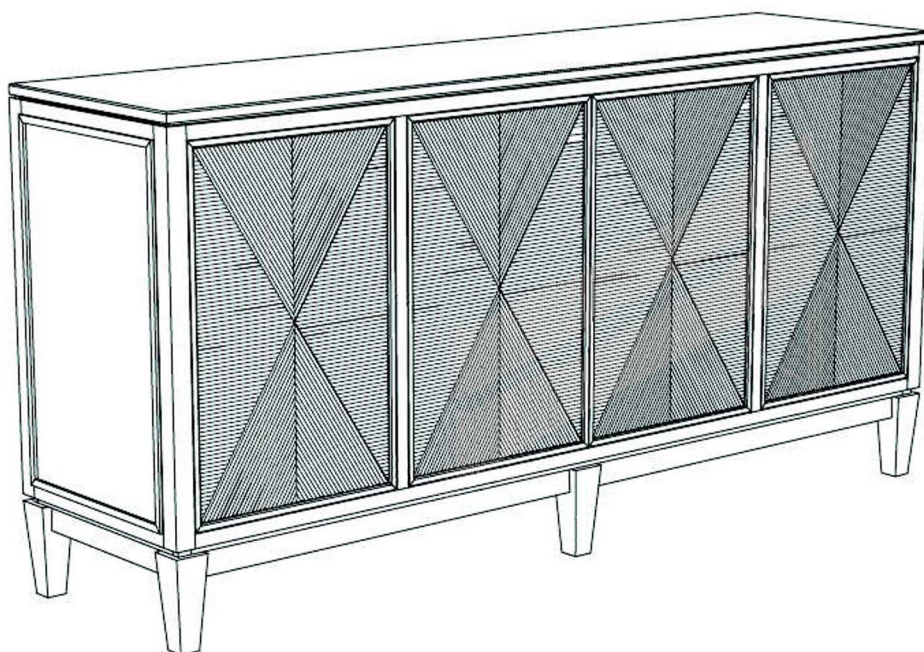
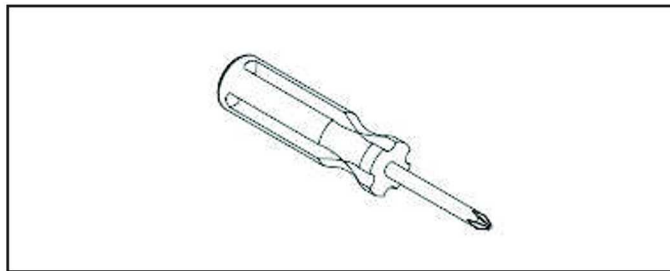



**GABBY**

**SAFFRON / STRELLA  
ASSEMBLY INSTRUCTION**

STEP 1 :

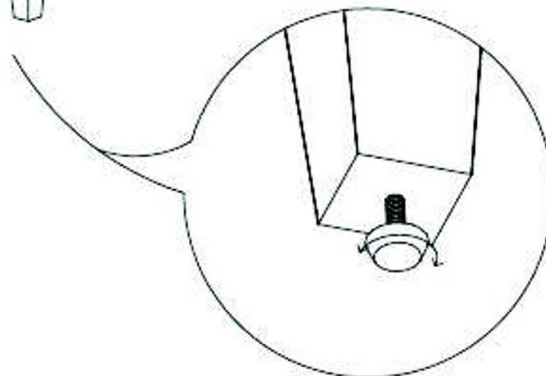
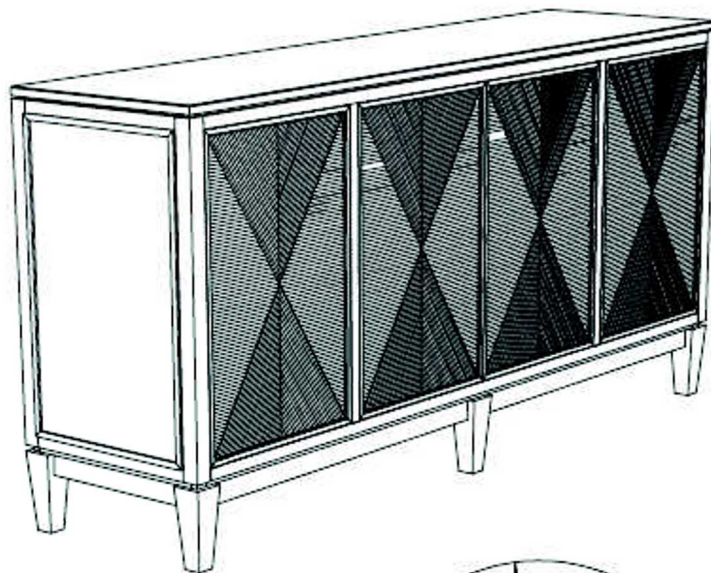

- If the floor is uneven adjust the levelers located at the underside of the Leg, to do this lift Up the side that need to be elevated to provide access to the levelers, turn the leveler until adequate contact with the floor.



**GABBY**  
**SAFFRON / STRELLA**  
**ASSEMBLY INSTRUCTION**

STEP 2 :

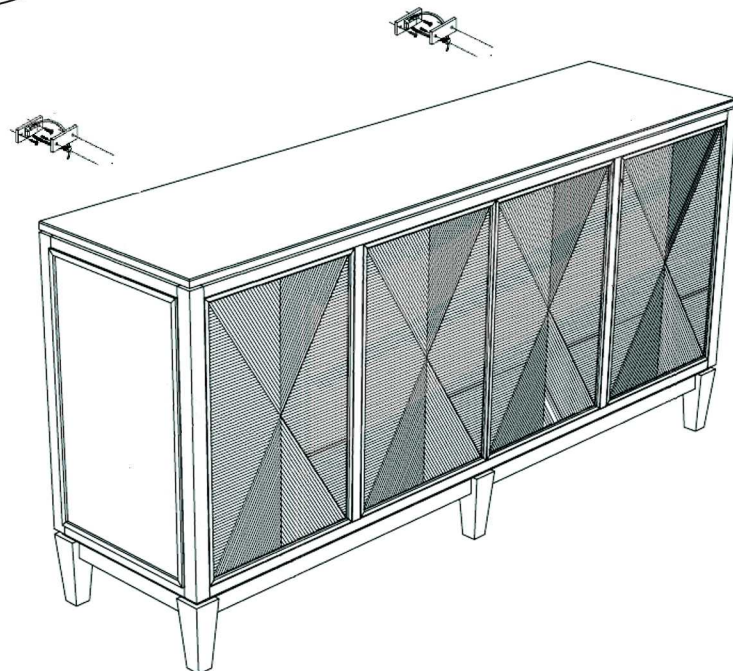
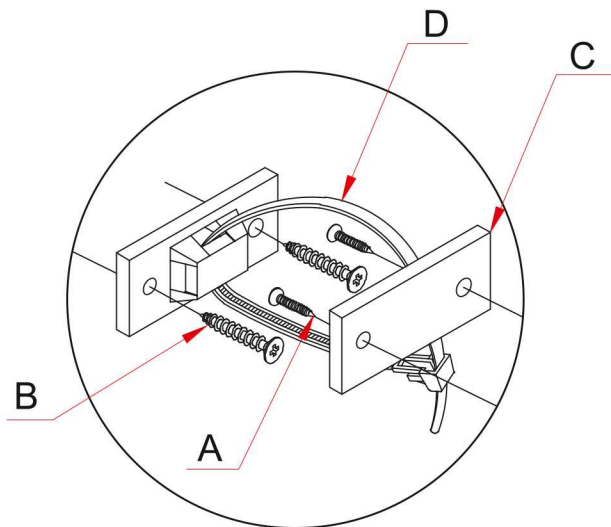

- Attach the Brackets (C) horizontally to the top of the back of the Table using the Small Screws (A) . Screw the remaining Brackets (C) vertically 1 inch below the brackets attached to the Table using the large screws (B) . The Large Screws (B) should be screwed into a stud in the wall. Align the Brackets vertically and string in the Retention Belt (D) . Confirm Strap is securely laced and locked.